

SONY®

bloggie™

Handbook

Mobile HD Snap Camera
MHS-PM5/PM5K

▼CLICK!



Table of contents



Getting started



Basic Operations



Using with your
computer



Using functions for
shooting



Using functions for
viewing



Customizing the settings



Enjoying the 360 Video
(MHS-PM5K)



Viewing images on a TV



Troubleshooting



Others



Index

Notes on using your camera

Types of memory card you can use with your camera

- The memory cards that you can use with this camera are “Memory Stick PRO Duo” media, “Memory Stick PRO-HG Duo” media, SD memory cards and SDHC memory cards. You cannot use a MultiMediaCard.
 - Memory cards of up to 32 GB have been confirmed to operate correctly with this camera.
 - “Memory Stick PRO Duo” media and “Memory Stick PRO-HG Duo” are collectively called “Memory Stick PRO Duo” media in this manual.
 - For recording movies, it is recommended that you use “Memory Stick PRO Duo” media of 1 GB or larger marked with:
 - MEMORY STICK PRO DUO* (“Memory Stick PRO Duo” media)
 - MEMORY STICK PRO-HG DUO (“Memory Stick PRO-HG Duo” media)
- * Marked with Mark2 or not, either can be used.
- See page 41 for the recordable time of “Memory Stick PRO Duo” media.

“Memory Stick PRO Duo”/“Memory Stick PRO-HG Duo” media



When using “Memory Stick PRO Duo” media with the standard size “Memory Stick” media compatible slot

Be sure to insert the “Memory Stick PRO Duo” media into the “Memory Stick Duo” media adaptor.

“Memory Stick Duo” media adaptor



Notes on the battery

- Charge the battery before using the camera for the first time.
- The battery can be charged even if it is not completely discharged. Also, even if the battery

is not fully charged, you can use the partially charged capacity of the battery as is.

- If you do not intend to use the camera for a long time, use up the existing charge and store the camera in a cool, dry place. This is to maintain the battery functions.
- For details on the battery, see page 68.

No compensation for contents of the recording

- The contents of the recording cannot be compensated for if recording or playback is not possible due to a malfunction of your camera or recording media, etc.

Internal memory and memory card back up

- Do not turn off the camera or remove the memory card while the access lamp is lit, or the internal memory data or the memory card data may be destroyed. Always protect your data by making a back up copy.

About changing the language setting

- The on-screen displays in each local language are used for illustrating the operating procedures. Change the screen language before using your camera if necessary (page 22).

Notes on recording/playback

- To ensure stable operation of the memory cards, we recommend that you format the memory card the first time you use it with this camera. However, if you format the memory card, all the data on the memory card will be deleted and you cannot restore that data. So, be sure to store your important data on the computer before formatting the memory card.
- This camera is neither dust-proof, nor splash-proof, nor water-proof.
- Before you record one-time events, make a trial recording to make sure that the camera is working correctly.
- Be careful not to get the camera wet. Water entering the inside of the camera may cause malfunctions which in some cases may not be repairable.
- If you rotate the lens portion back when your camera is connected to other devices with the USB connection support cable, the recorded images may be lost.

Notes on using your camera

- Do not aim the camera at the sun or other bright light. This may cause irrecoverable damage to your eyes. Or it may cause the malfunction of your camera.
- Do not use the camera near a location that generates strong radio waves or emits radiation. The camera may not be able to record or play back properly.
- Using the camera in sandy or dusty locations may cause malfunctions.
- If moisture condensation occurs, turn off the camera and leave it for about an hour before using it.
- Do not shake or strike the camera. In addition to malfunctions and an inability to record images, this may render the recording medium unusable, or cause image data breakdown, damage or loss.
- When inserting or ejecting the memory card, be careful so that the memory card does not pop out and drop.
- When connecting your camera to another device with a cable, be sure to insert the connector plug in the correct way. Pushing the plug forcibly into the terminal will damage the terminal and may result in a malfunction of your camera.
- Playback of movies other than those shot, edited or composed on this camera is not guaranteed.

Notes on the LCD screen and the lens

- The LCD screen is manufactured using extremely high-precision technology, so over 99.99% of the pixels are operational for effective use. However, there may be some tiny black points and/or bright points (white, red, blue or green in color) that constantly appear on the LCD screen. These points are normal in the manufacturing process and do not affect the recording in any way.

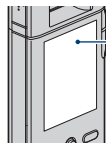

Black, white, red,
blue or green
points

- Exposing the LCD screen or the lens to direct sunlight for long periods may cause malfunctions. Be careful when placing the camera near a window or outdoors.
- Do not press against the LCD screen. The screen may be discolored and that may cause a malfunction.

- Images may trail across on the LCD screen in a cold location. This is not a malfunction.

Note on disposal/transfer

- When using software embedded in the camera, personal information such as IDs and mail addresses may be saved on the internal memory of the camera. When transferring the camera to others or on disposal, do so after deleting the information input.

On image data compatibility

- This camera supports “MP4 format” as movie file format. Therefore, movies recorded by this camera cannot be played on devices that do not support “MP4 format”.
- This camera does not support “AVCHD format” and therefore is not compatible with the playback and recording of movies in “AVCHD format” like a Digital HD Video camera recorder.
- Still images recorded by this camera are compressed/recorded in JPEG^{*1} format. The file extension is “.JPG”.
- This camera conforms with DCF^{*2} universal standard established by JEITA (Japan Electronics and Information Technology Industries Association)^{*3}.
- Playback of still images/movies recorded with your camera on other equipment and playback of still images recorded or edited with other equipment on your camera are not guaranteed.

^{*1} Joint Photographic Experts Group

^{*2} Design rule for Camera File system

^{*3} Japan Electronics and Information
Technology Industries Association

On the overheat protection

- The power may go off automatically to protect the camera depending on the temperature of the camera or the battery pack. In this case, the message appears on the screen before the power goes off. If the message “Camera overheating Allow it to cool” appears, the camera has been overheating. The power will go off automatically. Place the camera in a cool place until the temperature of the camera grows colder.

Warning on copyright

- Television programs, films, videotapes, and other materials may be copyrighted. Unauthorized recording of such materials may be contrary to the provisions of the copyright laws.

About this Handbook

- The photographs used as examples of pictures in this Handbook are reproduced images, and are not actual images shot using this camera.
- Design and specifications of recording media and other accessories are subject to change without notice.

Enjoying the camera

Enjoying high definition images

The movies shot with this camera will be recorded in MPEG-4 AVC/H.264 Main Profile, approximately 30 frames per second, Progressive, AAC LC, “MP4 format”.

- MPEG: Movie Picture Experts Group
- AVC: Advanced Video Codec

What is “MPEG-4 AVC/H.264”?

MPEG-4 AVC/H.264 is a standard of video camera, which uses highly efficient image compression encoding technology to record HD (high definition) images. Compared with the existing image compression encoding technology, MPEG-4 AVC/H.264 is able to compress images even more effectively.

- In the MPEG-4 AVC/H.264, the camera supports high definition images with effective scanning lines of 1080 or 720. The number of recorded image pixel is 1920×1080 or 1280×720, and the image is recorded in progressive mode*.

Progressive playback

The camera supports progressive mode*, which is used in computers, and therefore is suited for playing back images on computers.

Shooting movies in image quality suited for your purpose

The camera supports the common and widely used VGA (640×480) as well as HD (high definition) image quality. Select VGA (640×480) image quality to upload the recorded images on websites or to attach to mails without the need to convert the image quality.

Movie Size you can select with this camera

Movie Size	Usage guidelines
1920 × 1080 30P	Shoot HD (high definition) quality movies in sizes suited for display on computer or high definition TV
1280 × 720 60P	Shoots the rapidly moving action scenes such as sports smoothly with HD (high definition) quality
1280 × 720 30P	Shoot HD (high definition) quality movies in sizes suited for display on computer
640 × 480 30P	Shoot SD (standard definition) quality movies in sizes suited for uploading on websites

* The progressive mode is a type of movie recording method, which reads out all image pixels at once.

How to handle the camera

- When carrying the camera, rotate the lens portion back as illustrated.

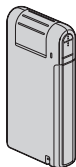

- Be careful not to block the lens with your finger when shooting.

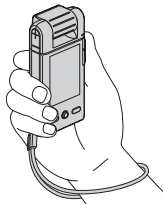
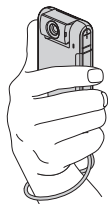

- Do not hold the camera by only holding the battery/memory card cover, jack cover, the USB jack or the lens portion.

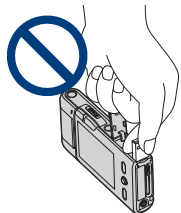

- See page 15 for how to attach the wrist strap.

Table of contents

Notes on using your camera	2
Enjoying the camera.....	5
How to handle the camera	6
Identifying parts.....	10
Indicators on the screen	12

Getting started

Checking the accessories supplied	15
1 Preparing the battery pack	16
2 Inserting the memory card	19
3 Turning the camera on/setting the language and clock.....	21

Basic Operations

Shooting images.....	23
Viewing images	27
Using the menu items.....	29
Menu items.....	30





Using with your computer

Using with your computer.....	31
Connecting the camera to the computer	33
Uploading videos and still images to media services.....	35
Using the software.....	38







Using functions for shooting

Shooting menu	40
Photo Size: Selecting the photo size according to use	
Movie Size: Selecting the movie size according to use	
SteadyShot: Allows you to reduce camera shake when shooting images	
Face Detection: Detects the faces of your subjects, and adjusts the exposure automatically	
Setup: Selecting the shooting settings	

Using functions for viewing

Viewing menu	43
 (Delete): Allows you to select and delete unwanted images	
 (Slideshow): Playing back a series of images	
 (Protect): Preventing accidental erasure	
 (Rotate): Rotating a still image	
 (Setup): Changing Setup items	

Customizing the settings

Using Setup items.....	46
 Shooting Setting	47
Flicker Reduction	
 Main Settings 1/2	48
Beep	Language Setting
LCD Backlight	Initialize
Display Color	
 Main Settings 2/2	49
LUN Settings	
Video Out	
 Memory Card Tool	50
Format	
Copy	
 Internal Memory Tool.....	51
Format	
 Clock Settings.....	52
Clock Settings	

Enjoying the 360 Video (MHS-PM5K)

Shooting 360 Video images	53
---------------------------------	----

Viewing images on a TV

Viewing images on a TV	55
------------------------------	----

Troubleshooting

Troubleshooting	58
Warning indicators and messages	64

Others

On the “Memory Stick” media	66
On the battery	68
Precautions	69
Specifications	70

Index

Index.....	71
------------	----

Identifying parts

See the pages in parentheses for details of operation.

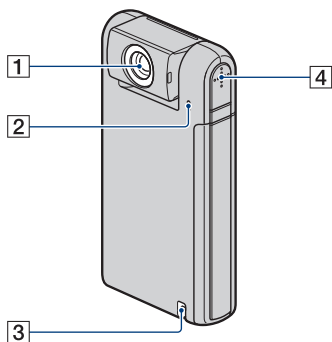

- 1 Lens
- 2 Microphone
- 3 Hook for wrist strap (15)
- 4 Speaker

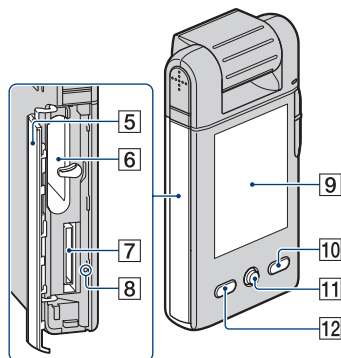

- 5 Battery/Memory card cover (19)
- 6 Battery slot
- 7 Memory card slot
- 8 Access lamp (20)
- 9 LCD screen (25)
- 10 MENU button (29)

- 11 Multi-selector
 - Menu on: ▲/▼/◀/▶ (29)
 - Menu off: ▲ (Screen display)/
▼ (Self-timer) (26)

- 12 ▶ (Play) button (27)

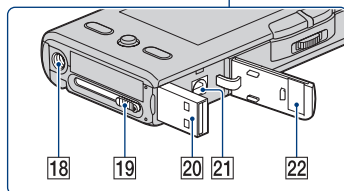
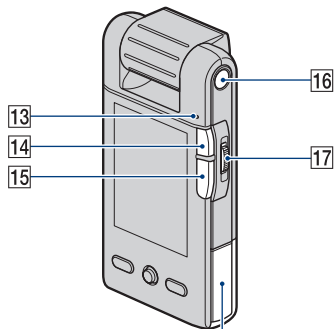

- 13 Power/Charge lamp (16)
 - The Power/Charge lamp lights up in green when the power is turned on, and lights up in orange while charging the battery.
- 14 📷 (Photo) button (23)
 - Shoots still images.
- 15 🎬 (Movie) button (23)
 - Starts/stops shooting movies.
- 16 ON/OFF button (21)
- 17 Zoom lever
 - For shooting: Zoom (W/T) (26)
 - For viewing: Playback zoom/
📐 (Index) (28)

Identifying parts

18 Tripod receptacle (bottom)

- Use a tripod with a screw length of less than 5.5 mm (7/32 inches). You will be unable to firmly secure the camera to tripods having screws longer than 5.5 mm (7/32 inches), and may damage the camera.

19 USB jack slide lever

20 (USB) jack (33)

- Used when connecting to a computer with a USB connection support cable.

21 A/V OUT jack (55)

- Used when connecting to a TV, etc. with an A/V connecting cable.

22 Jack cover

Indicators on the screen

When you tilt the multi-selector to ▲ (Screen display) repeatedly, the display changes (page 25).

Indicators on the screen disappear after about 5 seconds with the default settings in effect when you purchased this camera. If you want to make indicators appear again, carry out any operation other than those using the zoom lever. The indicators appear for only 5 seconds, however.

See the pages in parentheses for details of operation.

When shooting still images

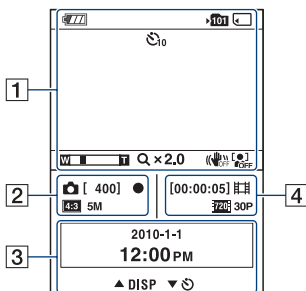

When recording movies



1

Display	Indication
	Battery remaining (18)
	Low battery warning (64)
	SteadyShot (42)
	Recording folder • This does not appear when using internal memory.
	Recording Media
	Face Detection (42)
	Zoom scaling Q x1.4
	Self-timer (26)





2

Display	Indication
	Image size (40)
	Information on the still image settings appears near the (Photo) icon.
[400]	Remaining number of recordable images (40)
	AE lock (green) (24)



3

Display	Indication
2010-1-1 12:00 PM	Current date and time
▲ DISP	Changing the screen display
▼	Using the self-timer

4

Display	Indication
 	Image size (40)
[00:00:05]	Remaining recordable time (40)
	Information on the movie settings appears near the  (Movie) icon.

5

Display	Indication
 	Image size (40)
●	Movie recording (red)
01:23	Recording time (41)

Note

- Indicators and their positions are approximate and differ from what you actually see.

When playing back still images

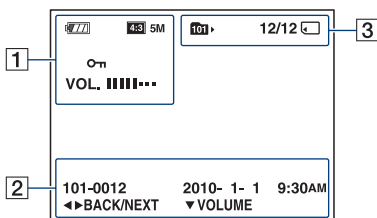

When playing back movies

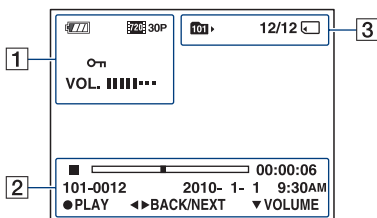

1

Display	Indication
	Battery remaining (18)
	Image size (40)
	Protect (44)
	Volume (27)
	Zoom scaling
	Low battery warning (64)

2

Display	Indication
	Playback bar
	Counter
	Recorded date/time of the playback image
	Select images
	Change the display setting with ▲, and adjust the volume with ▼. The guidance message is displayed alternately.

3

Display	Indication
	Playback folder • This does not appear when using internal memory.
	Image number/Number of images recorded in selected folder
	Playback Media

Note

- Indicators and their positions are approximate and differ from what you actually see.



Checking the accessories supplied

- Rechargeable battery pack NP-BK1 (1)

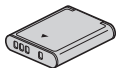

- Memory card (“Memory Stick PRO Duo” 4GB) (1) (MHS-PM5K only)

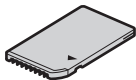

- A/V connecting cable (1)



- USB connection support cable (1)



- 360 Video Lens VCL-BPP1 (1) (MHS-PM5K only)

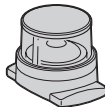

- 360 Video Lens Pouch (1) (MHS-PM5K only)
- Wrist strap (1)

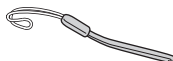

- CD-ROM (1)
 - “PMB” (software, including “PMB Help”)
 - bloggie Handbook (PDF)
- Instruction Manual
- Important Notice

Attach the strap and place your hand through the loop to prevent the camera from damage by being dropped, etc.

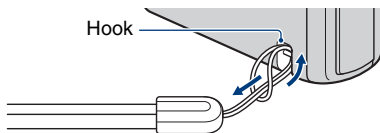

1 Preparing the battery pack

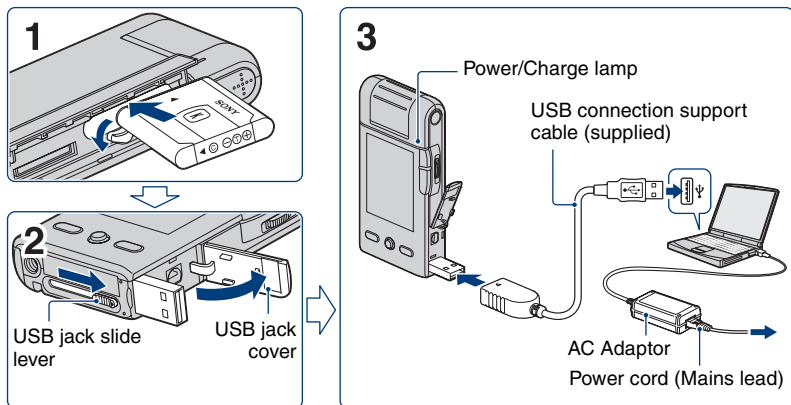

1 Open the battery/memory card cover and insert the battery pack into this camera, then close the cover.

- Insert the battery pack as far as it will go, then press the back of the battery pack gently until it clicks.
- You cannot open the battery/memory card cover when a tripod is attached to the camera.

2 Open the USB jack cover, then slide the USB jack slide lever.

3 Connect the camera to the computer that is turned on with the USB connection support cable (supplied).

- The Power/Charge lamp lights up in orange, and charging starts.
- When the Power/Charge lamp turns off, charging is finished.
- The Power/Charge lamp may turn off when the temperature is outside of the recommended operating temperature (10 to 30°C.)

4 When charging is finished, disconnect the USB connection support cable from the USB jack of your camera.

🔊 Notes

- While the camera is connected to a computer, you cannot operate the camera. Be sure to disconnect the camera before operation.
- Charging the battery with customized or hand-built computers is not guaranteed. Depending on the type of USB device used, charging may not function properly.

1 Preparing the battery pack

- Do not apply force to the camera, when you connect the camera to a computer. This may cause damage to the camera or the computer.
- When you connect the camera to a notebook computer that is not connected to an AC power source, the battery of the notebook computer may be depleted rapidly. Do not leave the camera connected to the computer for a long time.

To remove the battery pack

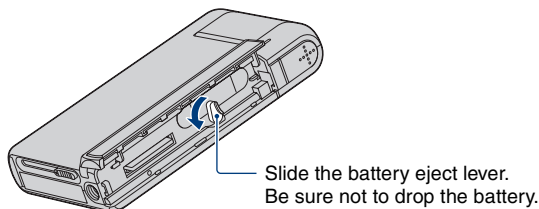

Charging time

Full charge time	
Approx. 300 min.	

- Time required to charge a fully depleted battery at a temperature of 25°C (77°F). Charging may take longer under certain circumstances or conditions.
- See page 40 for the number of images that can be recorded.
- When charging is finished, disconnect the USB connection support cable from the computer.

Approximate recording/playback time (min.)

Recording time ^{*1}	
Continuous recording time	95
Typical recording time ^{*2}	60





Playback time	
130	

^{*1} Shooting movies continuously with an image size of [1280 × 720 30P]

^{*2} Typical recording time shows the time when you repeat recording start/stop, turning the power on/off and zooming.

To check the remaining battery time

Rotate the lens portion or press the ON/OFF button to turn on and check the remaining battery on the LCD screen.

Battery remaining indicator					
Battery remaining guidelines	Sufficient power remaining	Battery almost fully charged	Battery half full	Battery low, recording/playback will stop soon.	Charge the battery. (The warning indicator flashes.)

- It takes about one minute until the correct battery remaining indicator appears.
- The displayed battery remaining indicator may not be correct under certain circumstances.
- If the camera is running on battery power and you do not operate the camera for about five minutes, the camera turns off automatically to prevent wearing down the battery (Auto power off function).
- The Language Setting screen appears when the camera is turned on for the first time (page 21).

2 Inserting the memory card

1

Battery/memory
card cover

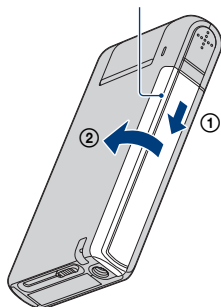

2

Be careful of the direction
of the notched corner.

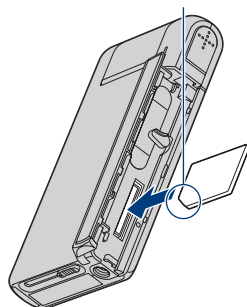

3

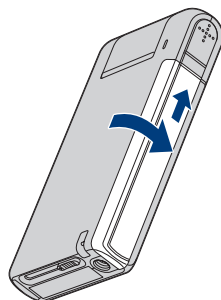

1 Open the cover.

2 Insert the memory card all the way in until it clicks with its notched corner directed downward as shown in the illustration.

3 Close the cover.

When there is no memory card inserted

The camera records/plays back images using the internal memory (approx. 26 MB).

When the movie size is set to [1920 × 1080 30P] or [1280 × 720 60P], you cannot record movies, however.

2 Inserting the memory card

To remove the memory card

Open the battery/memory card cover.

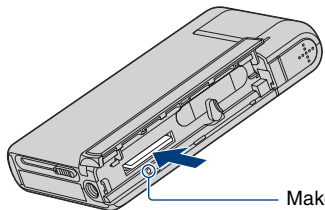

Make sure that **the access lamp** is not lit, then push the memory card in once.

- Never remove the memory card when the access lamp is lit. This may cause damage to data in the memory card.

3 Turning the camera on/setting the language and clock

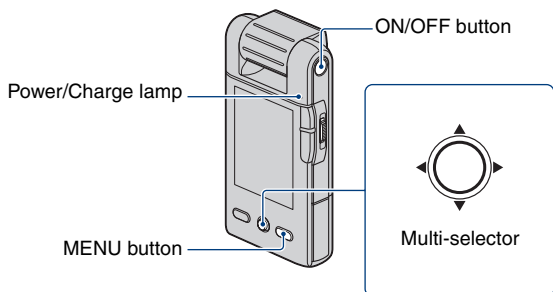

1 Rotate the lens portion to turn the power on.

- The Power/Charge lamp lights up in green.
- Rotating the lens portion in the arrow direction turns on the camera.

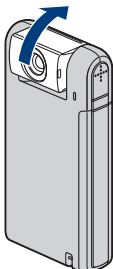

- You can also turn the power on by pressing the ON/OFF button.
- The lens rotates within the range of 0 to 270 degrees.

2 Select the desired language with the multi-selector tilt to ▲/▼, then press the multi-selector.

3 Set the clock with the multi-selector.

- 1 Select the date display format with ▲/▼, then press the multi-selector.
- 2 Select each item with ◀/▶ and set the numeric value with ▲/▼.
- 3 Select [OK] with ▶, then press the multi-selector.

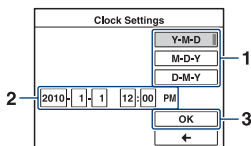



To turn the power off

Press the ON/OFF button.

- You can also turn the power off by rotating the lens portion back while the camera is in the recording mode.
- You cannot turn the power off, even if you rotate the lens portion back while the camera is in the playback mode.

To change the language settings

Press MENU and select  (Setup) →  (Main Settings 1/2) → [Language Setting] (page 48).

To change the date and time

Press MENU and select  (Setup) → [Clock Settings] (page 52).

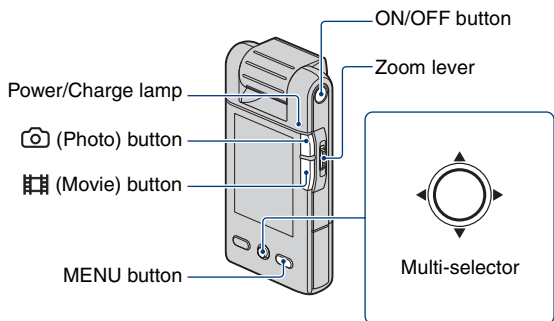

1 Rotate the lens portion to turn the power on.

- The Power/Charge lamp lights up in green.
- You can also turn the power on by pressing the ON/OFF button.

2 Confirm the composition.

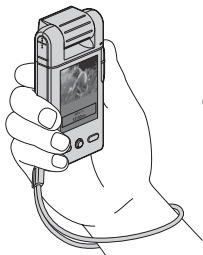

Position the subject in the center of the screen.

3 Start shooting.

When shooting still images:

① Press and hold  (Photo) halfway down.

A beep sound is heard, and the ● (AE lock) indicator (green) lights on the lower center, little toward the left side of the screen.

- The angle of view switches to the aspect ratio (4:3, 3:2 or 16:9) according to the shooting size of the still image. Black bands may appear depending on the setting of the image size.

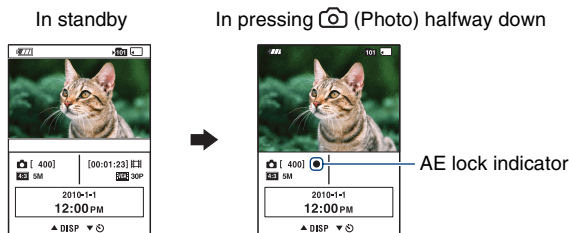

② Press  (Photo) fully down.

- You cannot shoot still images while shooting movies.
- When shooting still images, the angle of view may change from that in shooting standby.
- When a face is detected in shooting standby, a white frame appears. When multiple faces are detected, multiple frames appear. If you press and hold  (Photo) button halfway down, a white frame becomes green and the image quality is optimized automatically.

When shooting movies:

Press  (Movie) button.

- Start shooting movies.

To stop recording, press  (Movie) button again.



- Black bands appear on the top and bottom of the image when the image size is any of [1920 × 1080 30P], [1280 × 720 60P] or [1280 × 720 30P].
- Continuous shooting is possible for approximately 29 minutes.

Changing the screen display

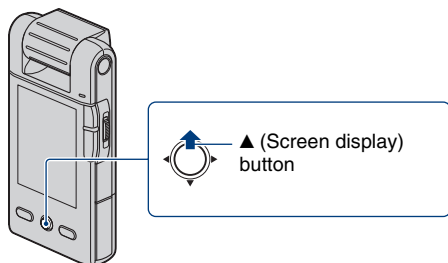

When you tilt the multi-selector to ▲ (Screen display) repeatedly, the display changes as follows.

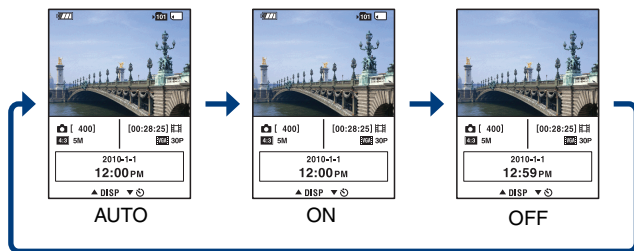

- Indicators on the screen disappear after about 5 seconds with the default settings in effect when you purchased the camera. The default setting is set to AUTO. If you want to make indicators appear again, carry out either of the following operations.
 - Tilt the multi-selector to ▲ (Screen display).
 - Carry out any operation other than those using the zoom lever. The indicators appear for only 5 seconds, however.
- By tilting to ▲ (Screen display) longer, you can increase the brightness of the LCD backlight. Tilt to ▲ (Screen display) longer again to return the brightness of the LCD backlight to normal.
- If you view images in bright outside light, adjust the brightness of the LCD backlight up. However, the battery power may decrease faster under such condition.
- The LCD screen will not display while the camera is connected to a TV.

Useful functions for shooting

W/T Using the zoom

Slide the zoom lever toward T to zoom in, slide the zoom lever toward W to zoom out. You cannot use the zoom function when the movie size is [1920 × 1080 30P].

⌚ Using the self-timer

Tilt the multi-selector to ▼ (Self-timer).



- You can change settings with the multi-selector tilt to ▼ (Self-timer) repeatedly.



⌚_{OFF} (Off): Not using the self-timer.

⌚₁₀ (10 sec): Shooting starts after a 10-second delay. Use this setting if you want to include yourself in the image.

⌚₂ (2 sec): Shooting starts after a 2-second delay. This is to prevent blurring due to unsteadiness when the shutter button is pressed.

If you press  (Photo) button and  (Movie) button, countdown timer is displayed, and after rapid beep sounds are heard, the camera will shoot.

Recording in mirror mode

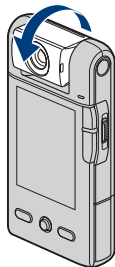

Rotate the lens portion to the same direction the LCD screen is facing.

- A mirror-image of the subject appears on the LCD screen, but the image will be normal when recorded.
- The same image as those recorded appears on the LCD screen instead of the mirror-image in playback mode.
- The image may become distorted when you rotate the lens portion from the front to the same direction the LCD screen is facing, or in the opposite way.

Viewing images

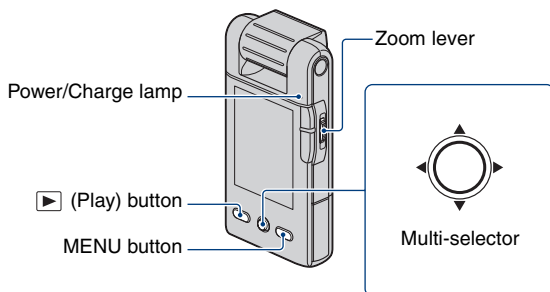

1 Press and hold (Play) button.

- Index screen appears.

2 Select the image you want to playback with the multi-selector tilt to ///.



Still image:



Press the multi-selector.

- A still image is displayed.

Movie:

Press the multi-selector to pause and playback a movie.

Tilt to  to fast forward,  to rewind. (Press the multi-selector to return to normal playback.)

Tilt to  to display the volume control screen, then adjust the volume with /.





- When shooting movies of fast moving subjects, such as a sport scene, the movie may not be played back smoothly.
- When the playback of the first movie ends, the playback of the next movie automatically starts. When the playback of the last movie ends, playback of movies will end.



To view an enlarged image (playback zoom)

Slide the zoom lever toward T while displaying a still image.

To undo the zoom, slide the zoom lever toward W.

Adjust the position: ///.

Cancel playback zoom: Press the multi-selector.

Viewing images

To return to the index screen

Slide the zoom lever toward  (Index) while displaying a still image or pausing the playback of a movie.

To delete the images

Allows you to select unwanted images for deletion.

You can delete images from the MENU button (page 43).

Using the menu items

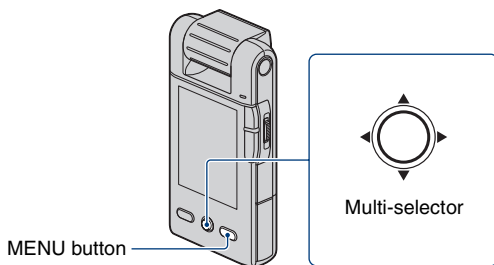

1 Press MENU to display the menu.

- The menu will be displayed only during shooting and playback mode.
- Different items will become visible depending on the selected mode.

2 Select the desired menu item with the multi-selector tilt to ▲/▼.

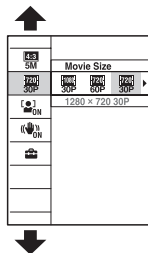

3 Select a setting with ▲/▼, then press the multi-selector.

4 Press MENU to turn off the menu.

Menu items

The available menu items vary depending on the camera mode.

The shooting menu is available only in the shooting mode, and the viewing menu is available only in the playback mode.

Only the available items are displayed on the screen.

Menu for shooting (page 40)

Photo Size

Movie Size

SteadyShot

Face Detection

Setup

Menu for viewing (page 43)

 (Delete)

 (Slideshow)

 (Protect)

 (Rotate)

 (Setup)



Using with your computer

“PMB” and other applications are contained on the CD-ROM (supplied) to allow more versatile use of images shot with your camera.

Recommended computer environment (Windows)

The following computer environment is recommended when using the supplied software “PMB” or “PMB Portable” and importing images via a USB connection.

OS (pre-installed)	Microsoft Windows XP ^{*1} SP3/Windows Vista ^{*2} SP2/Windows 7
Others	<p>CPU: Intel Pentium III 800 MHz or faster (For playing/editing the High Definition movies: Intel Core Duo 1.66 GHz or faster/Intel Core 2 Duo 1.20 GHz or faster)</p> <p>Memory: 512 MB or more (For playing/editing the High Definition movies: 1 GB or more)</p> <p>Hard Disk: Disk space required for installation—approximately 500 MB</p> <p>Display: Screen resolution: 1,024 × 768 dots or more</p>

^{*1} 64-bit editions and Starter (Edition) are not supported.

Windows Image Mastering API (IMAPI) Ver. 2.0 or later is required to use the function for creating discs.

^{*2} Starter (Edition) is not supported.

Recommended computer environment (Macintosh)

The following computer environment is recommended when using the supplied software, “PMB Portable” and importing images via a USB connection.

OS (pre-installed)	<p>USB Connection: Mac OS X (v10.3 to v10.6)</p> <p>PMB Portable: Mac OS X (v10.4 to v10.6)</p>
---------------------------	---

Notes

- Operation is not assured in an environment based on an upgrade of the operating systems described above or in a multi-boot environment.
- If you connect two or more USB devices to a single computer at the same time, some devices, including the camera, may not operate, depending on the types of USB devices you are using.
- Connecting the camera using a USB interface that is compatible with Hi-Speed USB (USB 2.0 compliant) allows advanced transfer (high speed transfer), as the camera is compatible with Hi-Speed USB (USB 2.0 compliant).
- When your computer resumes activity from suspend or sleep mode, communication between the camera and your computer may not recover at the same time.

Note on playback of movie files (MPEG-4 AVC/H.264)

To play back and editing movie files (MPEG-4 AVC/H.264) recorded by the camera, you need to install the software compatible with MPEG-4 AVC/H.264 or “PMB” on your computer.

- Even under a PC environment where operations are guaranteed, sometimes images cannot be played back smoothly due to dropped frames.
- Note that the transferred image itself is not affected.
- If you are using a notebook PC, be sure to use the PC with the AC adaptor plugged in. Sometimes normal operations are not possible due to the power savings function of the PC.

Note

- Operations are not guaranteed, even on computers fulfilling the above system requirements. For example, other open or background applications currently running may limit product performance.

Connecting the camera to the computer

Connect the camera as illustrated below.

- ① Turn the power on.

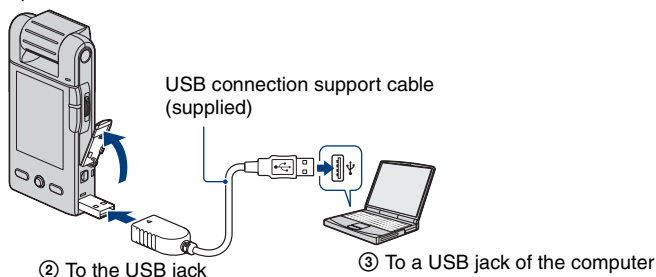

“PMB” allows you to easily import images.
For details on “PMB” functions, see the “PMB Help”.

Importing images to a computer (Windows)

Importing images to a computer without using “PMB”

When the AutoPlay Wizard appears after making a USB connection between the camera and a computer, click [Open folder to view files] → [OK] → [DCIM] or [MP_ROOT] → copy the desired images to the computer.

Importing images to a computer (Macintosh)

- 1** Connect the camera to your Macintosh computer first. Double-click the newly recognized icon on the desktop → [DCIM] or [MP_ROOT] → the folder where the images you want to import are stored.

- 2** Drag and drop the image files to the hard disk icon.

The image files are copied to the hard disk.

- 3** Double-click the hard disk icon → the desired image file in the folder containing the copied files.

The image is displayed.

Deleting the USB connection

Perform the procedures from step 1 to 3 below before:

- Removing a memory card.
- Inserting a memory card into the camera after copying images from the internal memory.
- Turning off the camera.

1 Double-click the disconnect icon on the task tray.

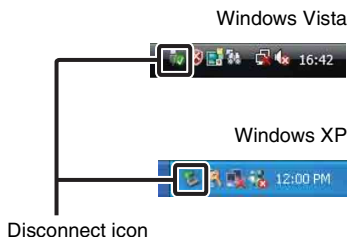

2 Click (USB Mass Storage Device) → [Stop].

3 Confirm the device on the confirmation window, then click [OK].

Note

- Drag and drop the icon of the memory card or the drive icon to the “Trash” icon beforehand when you use a Macintosh computer, and the camera is disconnected from the computer.

Uploading videos and still images to media services

The application software “PMB Portable” is pre-installed on the camera. You can do the following using “PMB Portable”.

- You can easily upload videos and still images to media services, such as a blog.
- You can upload your data via a computer connected to the Internet, even when you are away from home.
- You can add media services, such as a blog you frequently use.

For details, refer to help files of “PMB Portable”.

Starting up “PMB Portable” (Windows)

When you use the software for the first time, you must choose the language setting. Complete the following procedure. Once the setting is made, you can skip steps 3 to 5 after the next time.

1 Connect the camera to the computer using a USB connection.

- ① The connection of the camera and the computer is established, the auto execution wizard automatically starts.
- ② Eliminate the unwanted drives with [×].
 - If the auto execution wizard does not appear, click [Computer] ([My Computer] in Windows XP) → [PMBPORTABLE], then double-click [PMBP_Win.exe].

2 Click [PMB Portable].

- If [PMB Portable] does not appear on the auto execution wizard screen, Click [Computer] → [PMBPORTABLE], then double-click [PMBP_Win.exe].

(In Windows XP, click [PMB Portable] → [OK].

On a Macintosh, double-click [PMBP_Mac] in the [PMBPORTABLE] folder.)

The “Choose Setup Language” screen appears.

3 Select the desired language, then click [OK].

The area selection screen appears.

4 Select [Region] and [Country/Area].

The “License Agreement” screen appears.

5 Read the agreement carefully, then click [I Agree].

“PMB Portable” starts.

Starting up “PMB Portable” (Macintosh)

1 Make a USB connection between the camera and a computer.

When you connect the camera and your computer, [PMBPORTABLE] appears on the desktop. Click [×] to close any unnecessary drives.

2 Click [PMBP_Mac] in the [PMBPORTABLE] folder.

The Region Selection screen appears.

3 Select the appropriate [Region] and [Country/Area], and then click [OK].

The User Agreement screen appears.

4 Read the agreement carefully. If you accept the terms of the agreement, click [I Agree].

“PMB Portable” starts up.

🔊 Notes

- Set [LUN Settings] to [Multi] in the menu setting on the camera.
- Be sure to connect the computer to the network whenever you are using [PMB Portable].
- Depending on the service provider you use, when you upload videos and still images via the Internet, the cached data may be left on the computer. This may apply to this product, too.
- When problems occur with [PMB Portable], or you accidentally delete [PMB Portable], you can download the [PMB Portable] installer from the Internet and restore the software.

Notes on “PMB Portable”

You can download the URLs of some websites from servers managed by Sony Corporation (hereinafter called “the Sony server”) using “PMB Portable”.

Please note the following when you use image uploading services provided by these website (hereinafter called “the Services”) using “PMB Portable”.

- Depending on the websites, you may have to pay for registration or you may be charged for the Services. When you utilize the Services, follow the terms of any agreement prescribed by the websites.
- The Services may be discontinued or may be subject to change, depending on the circumstances of the administrators of the web sites. Including these cases, Sony Corporation is not responsible for the disputes between you and any third party, or damages you suffered in relation to the Services.
- Your requests for the websites are redirected by the Sony servers. You may not be able to access the desired websites, depending on various circumstances, such as server maintenance.

Uploading videos and still images to media services

- If we terminate the services provided by the Sony servers, we will notify you of the termination of the service on the Sony website in advance.
- We may record the URLs to which you are redirected by the Sony servers, and utilize the collected information for the improvement of the products or services offered by Sony. We never record personal information, however.

Using the software

Installing “PMB (Picture Motion Browser)”

1 Turn on your computer, and insert the CD-ROM (supplied) into the CD-ROM drive.

The installation menu screen appears.

- If it does not appear, double-click [Computer] (in Windows XP, [My Computer]) →  (SONYPMB).
 - If the AutoPlay screen appears, select “Run Install.exe” and follow the instructions that appear on the screen to proceed with the installation.
-

2 Click [Install].

The “Choose Setup Language” screen appears.

3 Select the desired language, then proceed to the following screen.

The “License Agreement” screen appears.

4 Carefully read the agreement, click the radio button (→) to accept the terms of the agreement, and then click [Next].

5 Follow the instructions on the screen to complete the installation.

- To continue the installation, connect the camera to the computer halfway through this step (page 33).
 - When the restarting confirmation message appears, restart the computer following the instructions on the screen.
 - DirectX may be installed depending on the system environment of your computer.
-

6 Remove the CD-ROM after the installation is complete.

7 Start up the software.

To start up “PMB”, click  (PMB) on the desktop.

For the detailed operation method, click  (PMB Help).

To start up “PMB” from the Start menu, select [Start] → [All programs] →  (PMB).

Notes

- Log on as Administrator.
- When “PMB” is started up for the first time, the confirmation message of the Information tool appears on the screen. Select [Start].

Introduction to “PMB”

- “PMB” allows you to import images shot with the camera to a computer for display. Make a USB connection between the camera and your computer, and click [Import].
- You can save and print images with the date.
- You can display images stored on a computer by shooting date in a calendar display.
- You can correct still images, and change the shooting date and time.
- You can create discs with CD or DVD disc-writing drive.
- You can upload images to media services. (An internet connection environment is required.)
- For other details, see  (PMB Help).



Shooting menu

The function in shooting mode using MENU button are described below. For details on how to operate the menu, see page 29.

The default settings are marked with ✓.

When the mode has been set to playback, switch it to shooting mode with (Play) button.

Photo Size: Selecting the photo size according to use

	Image size	Guidelines
✓	5M (2592×1944)	For prints up to A4 (8×10")
	3:2 (2592×1728)	3:2 aspect ratio as in photo prints and postcards
	3M (2048×1536)	For prints up to 10×15 cm (4×6") or 13×18 cm (5×7")
	16:9 (1920×1080)	For viewing on a high-definition TV
	VGA (640×480)	Shoot at a small image size for e-mail attachment





The approximate number of still images

(Units: Images)

Capacity Size/ Quality	Internal memory Approx. 26 MB	Memory card formatted with this camera					
		1 GB	2 GB	4 GB	8 GB	16 GB	32 GB
5M	6	390	770	1550	3100	6200	12400
3:2	10	550	1100	2200	4400	8800	17600
3M	17	620	1250	2500	5000	10000	20000
16:9	30	980	2000	4000	8000	16000	32000
VGA	110	6000	12000	23500	48000	96000	192000

- The number of still images may vary depending on the shooting conditions and the memory card.
- When the number of remaining shootable images is greater than 9,999, the ">9999" indicator appears.
- When images recorded using earlier Sony models are played back on this camera, the display may differ from the actual image size.
- When measuring media capacity, 1 GB equals 1 billion bytes, a portion of which is used for data management.

Movie Size: Selecting the movie size according to use

	Movie image size	Usage guidelines
	 1920 × 1080 30P*	Shoot HD (high definition) quality movies in sizes suited for display on computer or high definition TV
	 1280 × 720 60P	Shoots the rapidly moving action scenes such as sports smoothly with HD (high definition) quality
✓	 1280 × 720 30P	Shoot HD (high definition) quality movies in sizes suited for display on computer
	 640 × 480 30P*	Shoot SD (standard definition) quality movies in sizes suited for uploading on websites

* The range you can shoot is narrowed compared to [1280 × 720 30P] or [1280 × 720 60P].

- The movies shot with this camera will be recorded in MPEG-4 AVC/H.264 Main Profile, approximately 30 or 60 frames per second, Progressive, AAC LC, “MP4 format”.
 - MPEG: Movie Picture Experts Group
 - AVC: Advanced Video Codec
- The larger the image size, the higher the image quality.

The approximate recording time of movies

The table below shows the approximate maximum recording times. These are the total times for all movie files. Continuous shooting is possible for approximately 29 minutes.

(Units: hour : minute : second)

Capacity Size	Internal memory	Memory card formatted with this camera					
	Approx. 26 MB	1 GB	2 GB	4 GB	8 GB	16 GB	32 GB
1920 × 1080 30P	– (–)	0:10:00 (0:06:00)	0:20:00 (0:12:00)	0:40:00 (0:25:00)	1:20:00 (0:50:00)	2:40:00 (1:40:00)	5:20:00 (3:20:00)
1280 × 720 60P	– (–)	0:20:00 (0:10:00)	0:40:00 (0:20:00)	1:20:00 (0:40:00)	2:40:00 (1:30:00)	5:20:00 (3:10:00)	10:40:00 (6:20:00)
1280 × 720 30P	0:00:40 (0:00:25)	0:30:00 (0:15:00)	1:00:00 (0:30:00)	2:00:00 (1:00:00)	4:00:00 (2:10:00)	8:00:00 (4:20:00)	16:00:00 (8:40:00)
640 × 480 30P	0:01:20 (0:01:00)	1:00:00 (0:40:00)	2:00:00 (1:20:00)	4:00:00 (2:40:00)	8:00:00 (5:30:00)	16:00:00 (11:00:00)	32:00:00 (22:00:00)

- The number in () is the minimum recording time.
- The length of time for movies may vary depending on the shooting conditions.
- Before the continuous shooting ends, the recording time indicator flashes, and after a while, the recording will automatically stop.

Your camera uses the VBR (Variable Bit Rate) format to automatically adjust image quality to suit the recording scene. This technology causes fluctuations in the recording time of the memory card.

Movies containing quickly moving and complex images are recorded at a higher bit rate, and this reduces the overall recording time.

SteadyShot: Allows you to reduce camera shake when shooting images

<input checked="" type="checkbox"/>	On	Activates the camera shake reduction function.
<input type="checkbox"/>	Off	Does not activate the camera shake reduction function.

- The camera shake reduction function works only in [640 × 480 30P] or [1280 × 720 30P] mode.

Face Detection: Detects the faces of your subjects, and adjusts the exposure automatically

<input checked="" type="checkbox"/>	On	Activates the Face Detection function.
<input type="checkbox"/>	Off	Does not activate Face Detection function.

Setup: Selecting the shooting settings

You can change the settings on the  (setup) screen.



Viewing menu

The function in viewing mode using MENU button are described below. For details on how to operate the menu, see page 29.

When the mode has been set to shooting mode, switch it to playback with (Play) button.

(Delete): Allows you to select and delete unwanted images

This Image	Deletes the currently displayed image in single-image mode.
Multiple Images	Allows you to select and delete multiple images. ① Select an image then press the multi-selector. Repeat the above steps until there are no more images to be deleted. Select an image with a mark again to release the mark. ② MENU → [OK] → the multi-selector
Delete All Images	Deletes all images at once except protected images. Press [OK].

(Slideshow): Playing back a series of images

- ① Select the images you want to start slide show with the multi-selector tilt to /▼/◀/▶, then press the multi-selector.
- ② Press MENU to display the menu.
- ③ Select (Slideshow) with the multi-selector tilt to /▼, then press the multi-selector.
- ④ Select [Start] with /▼, then press the multi-selector to start playback.

To stop the slideshow

Press the multi-selector.

- You cannot resume the slideshow from this status.

To change the setup

Before starting slideshow, you can change the settings using the multi-selector.



The default settings are marked with .

Interval		
	1 sec	Sets the slide show interval.
✓	3 sec	
	5 sec	
	10 sec	

Repeat		
✓	On	Plays back images in a continuous loop.
	Off	After all the images have been played back, the slide show ends.

(Protect): Preventing accidental erasure

Protects recorded images against accidental erasure.
The  mark is displayed for registered images.

 (This Image)	Protects the currently displayed image in single-image mode.
 (Multiple Images)	<p>You can select and protect multiple images.</p> <p>① Select an image then press the multi-selector. Repeat the above steps until there are no more images to be protected. Select an image with a mark to release the mark.</p> <p>② MENU → [OK] → the multi-selector</p>

To cancel the protection





Select the image for which you want to cancel protection, and unlock it by pressing the multi-selector as the same procedure to protect it.



The indicator disappears, and the protection is released.

(Rotate): Rotating a still image



Rotates a still image.

- Press  (Play) button to set the camera to playback mode.
- Select the still image to rotate with the multi-selector tilt to ///, then press the multi-selector.
- Press MENU to display the menu.

- ④ Select [Rotate] with ▲/▼, then press the multi-selector.
 - ⑤ Select [ ], then rotate the image with ◀/▶.
 - ⑥ Select [OK] with ▲/▼, then press the multi-selector.
- You cannot rotate the following types of images.
 - Movies
 - Protected still images
 - You may not be able to rotate images shot with other cameras.
 - When viewing images on a computer, the image rotation information may not be reflected depending on the software.

(Setup): Changing Setup items

See page 46.



You can change the default settings using the Setup screen.

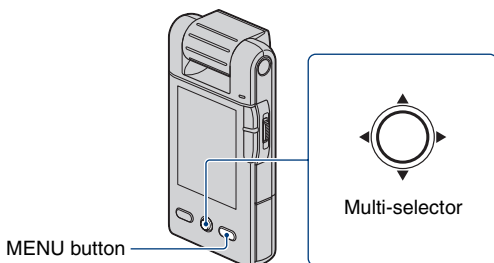

1 Press MENU to display the menu.

2 Tilt the multi-selector to ▲/▼ to select  (Setup).

3 Tilt to ▲/▼/◀/▶ to select the item you want to set.

The selected item is highlighted.

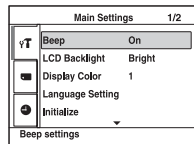

4 Tilt to ▶ to enter the setting.

You can also enter the setting by pressing the multi-selector.

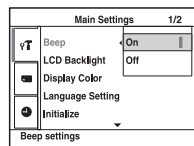

To turn off the Setup screen, press MENU.

To return to the menu from the Setup screen, tilt to ◀ repeatedly.

To cancel the setting change

Select [Cancel] if it appears, then press the multi-selector. If it does not appear, select the previous setting again.

- This setting is maintained even when the power is turned off.

The default settings are marked with ✓.

Flicker Reduction



Curbs the flicker generated by fluorescent by using the electro-shutter.

	On	Use the Flicker Reduction.
✓	Off	Does not use the Flicker Reduction.

The default settings are marked with .

Beep

Selects the sound produced when you operate the camera.

	On	Turns on the beep sound when you press the multi-selector,  (Photo) button or  (Movie) button.
	Off	Turns off the beep sound.

LCD Backlight

Selects the brightness of the LCD backlight.

	Bright	Brightens the LCD screen.
	Normal	Standard brightness.

- You can change the setting by tilting the multi-selector  (DISP) longer.
- Selecting [Bright] uses up the battery charge faster.

Display Color





You can select the background color of the LCD monitor from 3 colors.

Language Setting

Selects the language to be used to display the menu items, warnings, and messages.

Initialize

Initializes the setting to the default setting. Even if you execute this function, the images stored in the internal memory are retained.

- ① Select [Initialize] with the multi-selector tilt to , then press the multi-selector or tilt to .
The message "Reset to default settings" appears.
- ② Select [OK] with , then press the multi-selector.
The settings are reset to the default setting.

To cancel the resetting

Select [Cancel] in step ②, then press the multi-selector.

- Be sure not to turn the power of the camera off while initializing.

The default settings are marked with ✓.

LUN Settings

Allows you to select the settings for the display method of images on the recording media set in a connected equipment, such as a computer, when the camera is connected to a computer or AV equipment with a USB connection.

✓	Multi	Displays the images both on the memory card and in the internal memory of the camera. Select this when you connect the camera to a computer.
	Single	Displays only the images on the memory card when a memory card is inserted, and displays the images in the internal memory when a memory card is not inserted. Select this when you connect the camera to equipment other than a computer, and neither the images on the memory card nor the images in the internal memory of the camera are displayed.

Note

- Be sure to set [LUN Settings] to [Multi], while uploading videos and still images to media services using “PMB Portable”.

Video Out

Sets the video signal output according to the TV color system of the connected video equipment. Different countries and regions use different TV color systems. If you want to view images on a TV screen, check page 56 for the TV color system of the country or region where the camera is used.

NTSC	Sets the video output signal to NTSC mode (e.g., for the USA, Japan).
PAL	Sets the video output signal to PAL mode (e.g., for Europe, China).



This item appears only when the memory card is inserted in the camera.

Format

Formats the memory card.

To ensure stable operation of the memory cards, we recommend that you format the memory card the first time you use it with this camera. However, if you format the memory card, all the data on the memory card will be deleted and you cannot restore that data. So, be sure to store your important data on the computer before formatting the memory card.

- Note that formatting irrevocably erases all data on the memory card, including even protected images.

- ① Select [Format] with the multi-selector tilt to ▲/▼/◀/▶, then tilt to ►.
The message “All data on memory card will be erased” appears.
- ② Select [OK] with ▲, then press the multi-selector.
The format is completed.

To cancel the formatting

Select [Cancel] in step ②, then press the multi-selector.

Copy

Copies all images in the internal memory to the memory card.

- ① Insert the memory card.
- ② Select [Copy] with the multi-selector tilt to ▲/▼/◀/▶, then tilt to ►.
The message “All data on internal memory will be copied” appears.
- ③ Select [OK] with ▲, then press the multi-selector.
Copying starts.

To cancel the copying

Select [Cancel] in step ③, then press the multi-selector.

- Charge the battery sufficiently. Copying image files when the remaining battery amount is low can cause data transfer failure or damage the data due to battery exhaustion.
- You cannot copy individual images.
- The original images in the internal memory are retained even after copying. To delete the contents of the internal memory, remove the memory card after copying, then execute the [Format] command in [Internal Memory Tool] (page 51).
- When you copy the data in the internal memory to the memory card, a new folder is created. You cannot choose a specific folder on the memory card as the destination for the data to be copied.



This item appears only when the memory card is not inserted in the camera.

Format

Formats data stored in the internal memory.

- Note that formatting irrevocably erases all data in the internal memory, including even protected images.

- ① Select [Format] with the multi-selector tilt to ▲/▼/◀/▶, then tilt to ►.
The message “All data on internal memory will be erased” appears.
- ② Select [OK] with ▲, then press the multi-selector.
The format is completed.

To cancel the formatting

Select [Cancel] in step ②, then press the multi-selector.

Clock Settings

Sets the date and time.

- ① Select [Clock Settings] with the multi-selector tilt to ▲/▼, then press the multi-selector or tilt to ►.

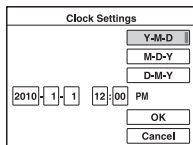

- ② Select the date display format with ▲/▼, then press the multi-selector.
- ③ Select each item with ◀/▶ and set the numeric value with ▲/▼.
- ④ Select [OK] with ▲/▼, then press the multi-selector.

To cancel the clock setting

Select [Cancel] in step ④, then press the multi-selector.



Shooting 360 Video images

By attaching the supplied 360 Video Lens to the camera, you can shoot 360-degree images of the area around the camera.

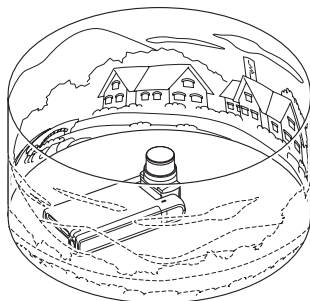

1 Rotate the lens portion, then attach the 360 Video Lens to the camera.

The camera shifts to the “360 Video” dedicated mode automatically. “Dedicated mode” means an automatic shift to the appropriate settings here.

The movie and photo size are as follows.

– Movie Size: 1280 × 720 30P

– Photo Size: 5M

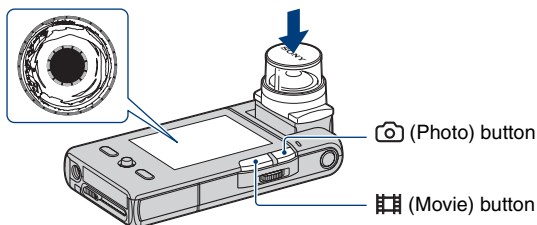

2 Start Shooting.

When shooting movies:

Press the ⏏ (Movie) button.

To stop recording, press the ⏏ (Movie) button again.

When shooting still images:

Press the ⌂ (Photo) button.

To remove the 360 Video Lens

Remove the 360 Video Lens after you have finished recording.

Using the self-timer function

It is often convenient to use the self-timer function when shooting.

Notes

- When you attach the 360 Video Lens during recording in normal mode, the camera does not shift to the “360 Video” dedicated mode automatically. The camera shifts to the “360 Video” dedicated mode when you stop recording.
- When you attach the 360 Video Lens to the camera, you cannot operate the following.
 - Zooming
 - MENU button
- Do not hold the camera by only holding the 360 Video Lens.

Viewing 360 Video images

When you play back images recorded using the 360 Video Lens, a ring-shaped image is displayed.

You can convert 360 Video images using the “PMB” software supplied with your camera, and view the converted images on your computer.

For details on the installation of “PMB”, see page 38.

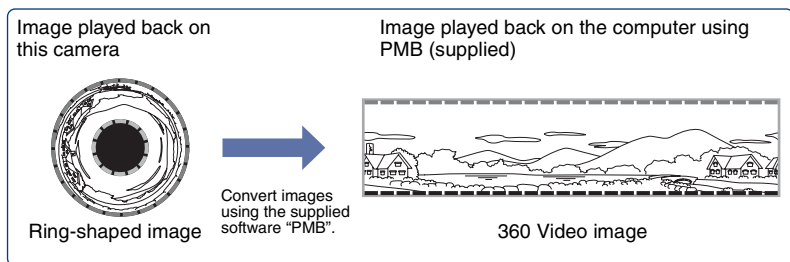

Notes

- You cannot view converted 360 Video images using only the camera.
- On the conversion confirmation screen of the supplied software “PMB”, set “Lens span” to “Narrow” for images recorded using the 360 Video Lens.
- When you convert 360 Video images and play them back, the resolution of the played back images is lower than that of normal images.



Viewing images on a TV

You can view images on a TV screen by connecting the camera to a TV.

The connection or the image quality (HD (high definition)/SD (standard definition)) varies depending on the type of TV or input jacks the camera is connected to.

- When using your camera abroad, it may be necessary to switch the video signal output to match that of your TV color system (page 49).
- Image will not be displayed on the LCD screen when an image signal is output to TV.

Connecting to a non-high-definition 16:9 (wide) or 4:3 TV

Images recorded with HD (high definition) quality is converted to SD (standard definition) and played back. Images recorded with SD (standard definition) image quality are played back with SD (standard definition) image quality.

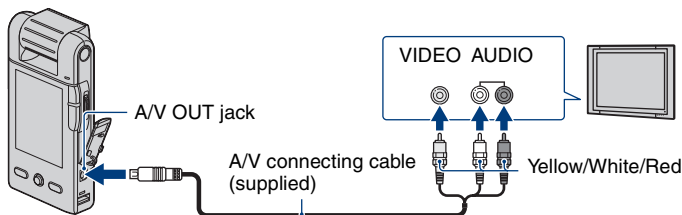

- During playback of a movie at HD (high definition) on SD (standard definition) TV, the movie is displayed with black space on the upper and lower sides.

Connecting to a high definition TV

Images recorded with HD (high definition) image quality are played back with HD (high definition) image quality. Images recorded with SD (standard definition) image quality are played back with SD (standard definition) image quality.

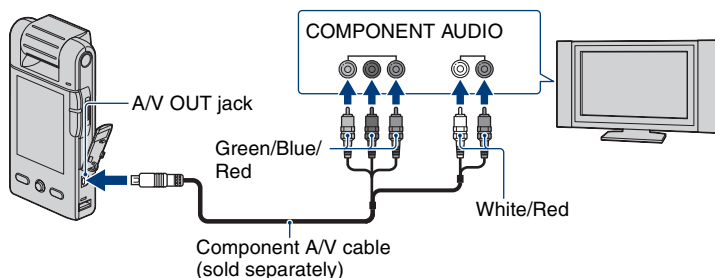

When connecting with the component A/V cable (sold separately)

- If you connect only component video plugs, audio signals are not output. Connect the white and red plugs to output audio signals.
- The output settings switches automatically according to the images played back. Therefore, the image may be distorted when switching the mode on the connected TV.
- If you record movies in HD (high definition) image quality [1920 × 1080 30P], [1280 × 720 60P], or [1280 × 720 30P] while connecting the camera to high definition TV with a component cable, the image output to the TV is shown in SD image quality.

When connecting to your TV via a VCR

Connect your camera to the LINE IN input on the VCR using the A/V connecting cable. Set the input selector on the VCR to LINE (VIDEO 1, VIDEO 2, etc.).

When your TV is monaural (When your TV has only one audio input jack)

Connect the yellow plug of the A/V connecting cable to the video input jack and connect the white (left channel) or red (right channel) plug to the audio input jack of your TV or VCR.

On TV color systems

If you want to view images on a TV screen, you need a TV with a video input jack and the A/V connecting cable. The color system of the TV must match that of your camera. Check the following lists for the TV color system of the country or region where the camera is used.

NTSC system

Bahama Islands, Bolivia, Canada, Central America, Chile, Colombia, Ecuador, Jamaica, Japan, Korea, Mexico, Peru, Surinam, Taiwan, the Philippines, the U.S.A., Venezuela, etc.

PAL system

Australia, Austria, Belgium, China, Czech Republic, Denmark, Finland, Germany, Holland, Hong Kong, Hungary, Italy, Kuwait, Malaysia, New Zealand, Norway, Poland, Portugal, Singapore, Slovak Republic, Spain, Sweden, Switzerland, Thailand, United Kingdom, etc.

PAL-M system

Brazil

PAL-N system

Argentina, Paraguay, Uruguay

SECAM system

Bulgaria, France, Guiana, Iran, Iraq, Monaco, Russia, Ukraine, etc.



If you experience trouble with your camera, try the following solutions.

1 Check the items on pages 59 to 63.

2 Turn the power off, and turn it on again after about one minute.

3 Consult your Sony dealer or local authorized Sony service facility.

When repairing the camera, we may check a minimum amount of data stored on the internal memory in order to improve the condition. However, Sony dealer will neither copy nor save your data.

Click one of the following items to jump to the page explaining the symptom and cause or the appropriate corrective action.

Battery and power

59

Deleting/Editing images

62

Shooting still images/movies

60

Memory card

63

Viewing images

61

Internal memory

63

Computers

62

Others

63

Battery and power

Cannot turn on the camera.

- The remaining battery is low or depleted.
 - Connect the camera to a computer that is turned on, and charge the battery fully (page 16).
 - If you cannot turn on the camera, even after you have charged the battery, remove the battery once, then insert it into the camera again.
- Check whether the battery is inserted in the correct direction (page 16).
- If your camera turns off automatically, rotate the lens portion back and rotate it again.

You cannot charge the camera.

- No indicators appears on the LCD screen in the charging mode.
 - Close the rotating lens and make a USB connection with your computer. Nothing appears on the LCD screen.
 - Confirm that the Power/Charge lamp (orange) is lit.
- The temperature of the battery pack is too low.
 - Remove the battery pack and place it in a warm place.
- The temperature of the battery pack is too high.
 - Remove the battery pack and place it in a cool place.
- The USB connection support cable is not properly connected to the computer.
 - Disconnect the USB connection support cable and then connect it again.
 - Be sure to use the USB connection support cable (supplied).
- The computer is not turned on.
 - Turn on the computer.
- The computer is in the standby (sleep or hibernation) mode.
 - Release the computer from sleep or hibernation status.
- You are using a USB hub.
 - You may not charge the battery when using a USB hub. Connect the camera to the USB connector of the computer directly.

The Power/Charge lamp does not light correctly while charging the battery pack.

- The temperature may be outside of the recommended operating temperature. Charge the battery pack in an recommended ambient temperature of between 10°C to 30°C (50°F to 86°F).
- For details, see page 68.

The battery life is short.

- The charging time is insufficient.
 - Depending on the conditions of the computer, it may take some time to charge this camera. Charge the camera until the icon shows the .

The power turns off suddenly.

- If you do not operate the camera for about five minutes while the power is on, the camera turns off automatically to prevent wearing down the battery. Turn on the camera again.
- The power may go off automatically to protect the camera depending on the temperature of the camera or the battery pack. In this case, the message appears on the screen before the power goes off.

The battery remaining indicator is incorrect.

- This phenomenon occurs when you use the camera in an extremely hot or cold location.
- The displayed battery remaining differs from the current one. Fully discharge and then charge the battery to correct the display.
- The battery is discharged. Charge the battery.

The operation of the camera is unstable while it is connected to a computer.

- You are using a USB hub or using a USB cable other than the supplied USB connection support cable.
 - Be sure to connect the camera directly to the USB connector of the computer using the USB connection support cable (supplied).

Shooting still images/movies

Your camera cannot record images.

- Check the free capacity of the internal memory or the memory card. If it is full, do one of the following:
 - Delete unnecessary images (pages 28, 43).
 - Change the memory card.
- It is recommended that you use a memory card of 1 GB or larger for recording movies.
- Continuous shooting is possible for approximately 29 minutes.
- Press  (Play) button and set the camera to recording mode to shoot a still image or a movie.
- The memory card may be damaged. Exchange the memory card for another one.
- When the movie size is [1920 × 1080 30P] or [1280 × 720 60P], you cannot record movies on the internal memory.
- The battery level is low.

The LCD screen does not display the still images or movies you are shooting.

- Your camera is set to the playback mode. Press  (Play) button to change to the recording mode (page 23).

The recording date is not superimposed on an image.

- This camera does not have a feature for superimposing dates on images.

The screen is too dark or too bright.

- Adjust the brightness of the LCD backlight (page 48).

Dots appear and remain on the screen.

- This is not a malfunction. These dots are not recorded (page 3).

Viewing images

Your camera cannot playback images.

- Press  (Play) button to change to the playback mode (page 27).
- The folder/file name has been changed on your computer.
- When an image file has been processed by a computer or when the image file was recorded using a model other than that of your camera, playback on your camera is not guaranteed.
- The memory card may be damaged. Exchange the memory card for another one.

The date and time are not displayed.

- In the default settings in effect when you purchased the camera, the setting of the screen display is set to AUTO. So indicators on the screen disappear after about 5 seconds. If you want to make indicators appear again, tilt the multi-selector to ▲ (Screen display) (page 25).

The image appears rough right after playback starts.

- The image may appear rough right after playback starts due to image processing. This is not a malfunction.

The image does not appear on the TV screen.

- Check [Video Out] to see if the video output signal of your camera is set to the color system of your TV (page 49).
- Check whether the connection is correct (page 55).
- If the USB connection support cable is connected to the camera and the computer, disconnect it.

You cannot view the image or hear the sound on the TV.

- When you are using the component video plug, make sure the red and white plugs of the A/V connecting cable are connected (pages 55, 56).

The top, bottom, right, and left edges of images may be trimmed slightly when you play back on a connected TV.

- The LCD screen of the camera can display recording images across the entire screen (full pixel display). However, this may cause slight trimming of the top, bottom, right, and left edges of images when played back on a TV which is not compatible with full pixel display.

When connecting to TV with A/V connecting cable, the image is displayed with black space on the upper and lower sides.

- This happens when viewing an image recorded at HD (high definition) on a 4:3 TV. This is not a malfunction.

The image recorded at HD (high definition) appears distorted.

- Set the wide mode of the TV to display the image recorded in the 16:9 mode correctly.

Computers

You cannot install “PMB”.

- Check the computer environment required to install “PMB”.
- Install “PMB” in an orderly manner (page 38).

After making a USB connection, “PMB Portable” does not start.

- Make the USB connection after the computer is turned on.
- Set [LUN Settings] to [Multi] (page 49).
- Connect the computer to the network.

“PMB” does not work correctly.

- Finish “PMB” and restart your computer.

Your camera is not recognized by the computer.

- Disconnect devices from the USB jack of the computer other than the keyboard, mouse, and your camera.
- Disconnect the USB connection support cable from the computer and the camera, and restart the computer, then connect the computer and your camera again in an orderly manner (page 33).
- Make sure the media check tool of the computer activates. For details on the media check tool, see “PMB Help” (page 38).
- Install “PMB” (page 38).

Deleting/Editing images

Your camera cannot delete an image.

- Cancel the protection (page 44).

Memory card

Cannot insert a memory card.

- Insert it in the correct direction.

You have formatted a memory card by mistake.

- All the data on the memory card is deleted by formatting. You cannot restore it.

Internal memory

Cannot playback or record images using the internal memory.

- There is a memory card inserted in the camera. Remove it.

Cannot copy the data stored in the internal memory to the memory card.

- The memory card is full. Check the capacity.

Cannot copy the data on the memory card or the computer to the internal memory.

- Data on the memory card or a computer cannot be copied to the internal memory.

Others

The lens gets fogged.

- Moisture condensation has occurred. Turn off the camera and leave it for about an hour before using it.

The camera becomes warm when you use it for a long time.

- This is not a malfunction.

The Language Set screen appears when you turn on the camera.

- Set the language again (page 48).

You want to change the date or time.

- Set the date and time again (page 52).

Warning indicators and messages

Messages

If the following messages appear, follow the instructions.



- The battery level is low. Charge the battery immediately.

Internal memory error

- Turn the power off and then on again.

System error

- Turn the power off and then on again.

Reinsert the memory card

- Insert the memory card correctly (page 19).
- The inserted memory card cannot be used in your camera (page 2).
- The memory card is damaged.
- The terminal section of the memory card is dirty.

(Warning indicator pertaining to battery pack temperature)

- Wait until the temperature of the camera grows cool.

Memory card type error

- The inserted memory card cannot be used in your camera (page 66).

Cannot access memory card Access denied

- You are using a memory card with the access controlled.
- The memory card may be damaged. Exchange the memory card for another one.

Error formatting memory card

- Format the media again (page 50).

No memory space on internal memory

- Delete unnecessary images or files (pages 28, 43).

Read only memory card

- Your camera cannot record or delete images on this “Memory Stick PRO Duo” media.

Folder error

- A folder with the same first three digit number already exists on the memory card (for example: 123MSDCF and 123ABCDE).

Cannot create more folders

- The folder with a name beginning with “999” exists on the memory card. You cannot create any folders if this is the case.

File error

- An error occurred while the image was playing back.

File protected

- Release the protection (page 44).

Turn the power off and on again

- A problem with the lens caused an error.

Camera overheating **Allow it to cool**

- The camera temperature has risen. The power may go off automatically, or you may be unable to record movies. Leave the camera in a cool location until the temperature goes down.



On the “Memory Stick” media

“Memory Stick” media is a compact, portable IC recording medium with a large data capacity.

You can use the following types of “Memory Stick” media listed below on this camera. However, we do not guarantee the operation of all types of “Memory Stick” media on your camera. (See the list below for more details.)

Types of “Memory Stick” media	Recording/Playback
“Memory Stick Duo” media (with MagicGate)	—
“Memory Stick PRO Duo” media	○
“Memory Stick PRO-HG Duo” media	○*

* Your camera does not support an 8-bit parallel data transfer. A 4-bit parallel data transfer, as same as “Memory Stick PRO Duo” media, is supported.

- Your camera cannot record or play data that uses “MagicGate” technology. “MagicGate” is a copyright protection technology that records and transfers the contents in an encrypted format.
- Your camera is compatible with “Memory Stick Micro” (“M2”) media. “M2” is the abbreviation for the “Memory Stick Micro”.
- “Memory Stick PRO Duo” media formatted by a computer (Windows OS/Mac OS) does not have guaranteed compatibility with your camera.
- Data read/write speed may vary depending on the combination of the “Memory Stick PRO Duo” media and “Memory Stick PRO Duo” media compliant product you use.
- Damaged or lost image data will not be compensated for, and may occur in the following cases:
 - If you eject the “Memory Stick PRO Duo” media or turn the power off on your camera while your camera is reading or writing image files on the “Memory Stick PRO Duo” media (while the access lamp is lit or flashing).
 - If you use the “Memory Stick PRO Duo” media near magnets or magnetic fields.
- It is recommended you make a back-up of important data on the hard disk of a computer.
- Do not attach a label or the like on “Memory Stick PRO Duo” media or a “Memory Stick Duo” media adaptor.
- Do not touch, or allow metallic objects to come into contact with the terminals.
- Do not bend, drop or apply strong force to the “Memory Stick PRO Duo” media.
- Do not disassemble or modify the “Memory Stick PRO Duo” media.
- Do not let the “Memory Stick PRO Duo” media get wet.
- Be careful to keep “Memory Stick PRO Duo” media out of the reach of small children. There is danger that a child might swallow it.
- Do not insert anything other than “Memory Stick PRO Duo” media into the “Memory Stick Duo” media slot. Doing so may cause a malfunction.
- Do not use or keep the “Memory Stick PRO Duo” media in the following locations:
 - Places subject to extremely high temperature, such as a car parked outside in the summer.
 - Places under direct sunlight.
 - Places with extremely high humidity or subject to corrosive gases.

On the “Memory Stick Duo” media adaptor

- When using “Memory Stick PRO Duo” media with a “Memory Stick” media compliant device, be sure to insert the “Memory Stick PRO Duo” media into a “Memory Stick Duo” media adaptor.
- When inserting “Memory Stick PRO Duo” media into a “Memory Stick Duo” media adaptor, make sure the “Memory Stick PRO Duo” media is inserted facing in the correct direction, then insert it all the way in. Note that improper use may cause a malfunction. Also, if you force the “Memory Stick PRO Duo” media into the “Memory Stick Duo” media adaptor in the wrong direction, it may be damaged.
- Do not insert a “Memory Stick Duo” media adaptor without “Memory Stick PRO Duo” media attached. Doing so may result in malfunctions of the camera.

Notes on using “Memory Stick Micro” media

- To use “Memory Stick Micro” media with this camera, you need a Duo-sized M2 Adaptor. Insert the “Memory Stick Micro” media into the Duo-sized M2 Adaptor, then insert the adaptor into the “Memory Stick Duo” media slot. If you insert “Memory Stick Micro” media into this camera without using a Duo-sized M2 Adaptor, you might not be able to remove it from the camera.
- Do not leave the “Memory Stick Micro” media within the reach of small children. They might accidentally swallow it.

On image data compatibility

- Image data files recorded on “Memory Stick PRO Duo” media by your camera conform to the “Design rule for Camera File system” universal standard established by the JEITA (Japan Electronics and Information Technology Industries Association).
- On your camera, you cannot play back still images recorded on other devices that do not conform to the universal standard. (These models are not sold in some regions.)
- If you cannot use “Memory Stick PRO Duo” media that has been used with another device, format it with your camera (page 50). Note that formatting erases all information on the “Memory Stick PRO Duo” media.
- You may not be able to play back images with your camera:
 - When playing back image data modified on your computer.
 - When playing back image data recorded with other devices.

On the battery

On charging the battery

- We recommend charging the battery in an ambient temperature of between 10°C to 30°C (50°F to 86°F). You may not be able to efficiently charge the battery outside of this temperature range.
- You may not charge the battery pack, or the Power/Charge lamp may not light in the following.
 - When the temperature of the battery pack is too low.
Remove the battery pack and place it in a warm place.
 - When the temperature of the battery pack is too high.
Remove the battery pack and place it in a cool place.
- For details, see page 16.

Effective use of the battery

- Battery performance decreases in low temperature surroundings. So, the time that the battery can be used is shorter in cold places. We recommend the following to ensure longer battery use:
 - Put the camera in a pocket, etc. to warm it up before using.
- The battery will run out quickly if you use the zoom frequently.
- Avoid rough handling, disassembling, modifying, physical shock, or impact such as hammering, dropping or stepping on the battery pack.
- Do not use a deformed or damaged battery pack.

How to store the camera

- If the camera is not to be used for a long time, to maintain its function, fully charge the internal battery and use it up at least once a year, then store the camera in a dry, cool place.
- To use the battery up, leave your camera in slide show (page 43) playback mode until the power goes off.

On battery life

- The battery life is limited. Battery capacity decreases little by little as you use it more and more, and as time passes. If the battery operating time seems shortened considerably, a probable cause is that the battery has reached

the end of its life. Contact your Sony dealer or local authorized Sony service facility.

- The battery life varies according to how it is stored and the operating conditions and environment.

On disposing the battery

- Contact the nearest Sony dealer when disposing the battery.

On the internal rechargeable backup battery

This camera has an internal rechargeable battery for maintaining the date and time and other settings regardless of whether the power is on or off.

This rechargeable battery is continually charged as long as you are using the camera. However, if you use the camera for only short periods, it discharges gradually, and if you do not use the camera at all for about one week it becomes completely discharged. In this case, be sure to charge this rechargeable battery before using the camera.

However, even if this rechargeable battery is not charged, you can still use the camera, but the date and time will not be indicated.

Charging method of the internal rechargeable backup battery

Insert charged battery pack in the camera, and then leave the camera for 24 hours or more with the power off.

Precautions

Do not use/store the camera in the following places

- In an extremely hot, cold or humid place
In places such as in a car parked in the sun, the camera body may become deformed and this may cause a malfunction.
- Under direct sunlight or near a heater
The camera body may become discolored or deformed, and this may cause a malfunction.
- In a location subject to rocking vibration
- Near strong magnetic place
- In sandy or dusty places
Be careful not to let sand or dust get into the camera. This may cause the camera to malfunction, and in some cases this malfunction cannot be repaired.

On carrying

Do not sit down in a chair or other place with the camera in the back pocket of your trousers or skirt, as this may cause malfunction or damage the camera.

On cleaning

Cleaning the LCD screen

Wipe the screen surface with an LCD cleaning kit (sold separately) to remove fingerprints, dust, etc.

Cleaning the lens

Wipe the lens with a soft cloth to remove fingerprints, dust, etc.

Cleaning the camera surface

Clean the camera surface with a soft cloth slightly moistened with water, then wipe the surface with a dry cloth. Do not use the following or they may damage the finish or the casing.

- Chemical products such as thinner, benzene, alcohol, disposable cloths, insect repellent, sunscreen or insecticide, etc.
- Do not touch the camera with the above on your hand.
- Do not leave the camera in contact with rubber or vinyl for a long time.

On operating temperatures

Your camera is designed for use under the temperatures between 0°C and 40°C (32°F and 104°F). Shooting in extremely cold or hot places that exceed this range is not recommended.

On moisture condensation

If the camera is brought directly from a cold to a warm location, moisture may condense inside or outside the camera. This moisture condensation may cause a malfunction of the camera.

If moisture condensation occurs

Turn off the camera and wait about an hour for the moisture to evaporate. Note that if you attempt to shoot with moisture remaining inside the lens, you will be unable to record clear images.

Specifications

Camera

[System]

Image device: 7.13 mm (1/2.5 type) CMOS sensor

Total pixel number of camera:

Approx. 5 038 000 (2 592 × 1 944) pixels

Effective pixel number of camera:

Approx. 5 038 000 (2 592 × 1 944) pixels
(still images), Approx. 2 073 000 pixels
([1920 × 1080 30P] movie)

Lens: F3.6

f = 7.0 mm (9/32 inches)

When converted to a 35 mm still camera

For movies: 47 mm (1 7/8 inches) (16:9)

For still images: 42 mm (1 11/16 inches) (4:3)

Exposure control: Automatic exposure

File format:

Still images: JPEG (DCF Ver. 2.0, Exif
Ver. 2.21, MPF Baseline) compliant
Movies: MPEG-4 AVC/H.264 (.MP4)
Audio: MPEG AAC

Recording media: Internal Memory (approx.
26 MB), "Memory Stick PRO Duo",
SD memory card, SDHC memory card (Class
4, 6, 10)

[Input and Output connectors]

Multi use terminal (A/V-out
(SD/HD Component)):

Video output

Audio output (monaural)

USB jack: type A (built-in)

USB communication: Hi-Speed USB (USB 2.0
compliant)

[LCD screen]

LCD screen: 6.1 cm (2.4 type) TFT drive

Total number of dots: 230 400 (960 × 240) dots

[Power, general]

Power: Rechargeable battery pack NP-BK1, 3.6 V

Power consumption: 1.9 W (when the movie
image size is [1280 × 720 30P])

Operating temperature: 0 to 40°C (32 to 104°F)

Storage temperature: -20 to +60°C (-4 to +140°F)

Dimensions: Approx. 19.0 × 108.0 × 54.0 mm
(3/4 × 4 3/8 × 2 1/4 inches) (W/H/D,
excluding protrusions)

Mass (including NP-BK1 battery pack, memory
card): Approx. 130 g (4.6 oz)

Microphone: Monaural

Speaker: Monaural

Rechargeable battery pack NP-BK1

Used battery: Lithium-ion battery

Maximum output voltage: DC 4.2 V

Mean output voltage: DC 3.6 V

Maximum charge voltage: DC 4.2 V

Maximum charge current: 1.4 A

Capacity:

typical: 3.4Wh (970mAh)

minimum: 3.3Wh (930mAh)

Design and specifications are subject to change
without notice.

Trademarks

- "bloggie" is a trademark of Sony Corporation.
- "Memory Stick", , "Memory Stick PRO", **MEMORY STICK PRO**, "Memory Stick Duo", **MEMORY STICK DUO**, "Memory Stick PRO Duo", **MEMORY STICK PRO DUO**, "Memory Stick Micro", "MagicGate", and **MAGICGATE** are trademarks of Sony Corporation.
- Microsoft, Windows, Windows Vista and DirectX are either registered trademarks or trademarks of Microsoft Corporation in the United States and/or other countries.
- Macintosh, Mac OS, iMac, iBook, PowerBook, Power Mac and eMac are trademarks or registered trademarks of Apple Inc.
- Intel and Pentium are trademarks or registered trademarks of Intel Corporation.
- 360 Video is a trademark of Sony Corporation.
- SDHC logo is a trademark. 
- MultiMediaCard is a trademark of the MultiMediaCard Association.

In addition, system and product names used in this manual are, in general, trademarks or registered trademarks of their respective developers or manufacturers. However, the TM or ® marks are not used in all cases in this manual.

**Numerics**

- 360 Video images53
- 4:3 TV55

A

- A/V connecting cable55
- A/V OUT jack55
- AE lock indicator24

B

- Battery68
- Beep48

C

- CD-ROM31
- Clock Settings52
- Computer31
 - Importing images33
- Connecting
 - 4:3 TV55
 - Computer33
 - High definition TV56
 - Wide TV55
- Copy50

D

- Date52
- Delete43

F

- Face Detection42
- Flicker Reduction47
- Format50, 51

H

- High definition TV56
- How to handle the camera6

I

- Identifying parts 10
- Index screen27
- Indicator12
- Initialize48
- Install38
- Internal Memory Tool 51

L

- Language Setting48
- LCD Backlight48
- LUN Settings49

M

- Macintosh computer31
- Main Settings48
- Memory card2
- Memory Card Tool50
- “Memory Stick PRO Duo”
media66
- Menu
 - Items30
 - Shooting40
 - Viewing43
- Mirror mode26

N

- NTSC49

O

- ON/OFF button 10, 21
- OS31

P

- PAL49
- Playback zoom27
- PMB38
- Protect44

R

- Rechargeable battery 15, 70
- Rotate44

S

- Screen
 - Indicator12
 - LCD backlight48
- Self-timer26
- Setup45
- Shooting40
 - Movies24
 - Still image24
- Shooting Setting47
- Slideshow43
- Software38
- SteadyShot42

T

- Troubleshooting58

V

- VGA40
- Video Out49
- Viewing43
- Viewing images27
- Volume27

W

- Warning indicators and
messages64
- Wide TV55
- Windows computer31

Z

- Zoom26

Notes on the License

THIS PRODUCT IS LICENSED UNDER THE AVC PATENT PORTFOLIO LICENSE FOR THE PERSONAL AND NON-COMMERCIAL USE OF A CONSUMER TO

(i) ENCODE VIDEO IN COMPLIANCE WITH THE AVC STANDARD (“AVC VIDEO”) AND /OR

(ii) DECODE AVC VIDEO THAT WAS ENCODED BY A CONSUMER ENGAGED IN A PERSONAL AND NON-COMMERCIAL ACTIVITY AND/OR WAS OBTAINED FROM A VIDEO PROVIDER LICENSED TO PROVIDE AVC VIDEO. NO LICENSE IS GRANTED OR SHALL BE IMPLIED FOR ANY OTHER USE. ADDITIONAL INFORMATION MAY BE OBTAINED FROM MPEG LA, L.L.C. SEE <[HTTP://MPEGLA.COM](http://MPEGLA.COM)>

Additional information on this product and answers to frequently asked questions can be found at our Customer Support Website.

<http://www.sony.net/>